

CTP-BV-1001-H-Z CTP-7BV-1001-H-Z

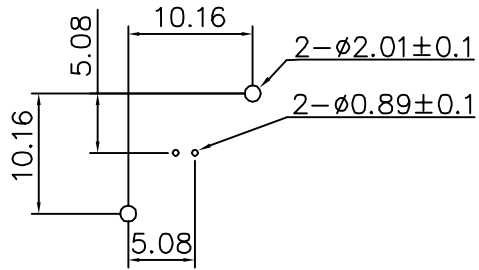

RECOMMENDED PC BOARD LAYOUT
WITHOUT MOUNTING POSTS

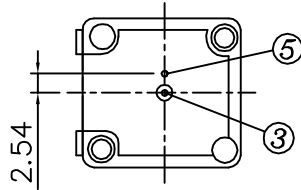
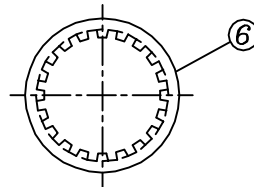
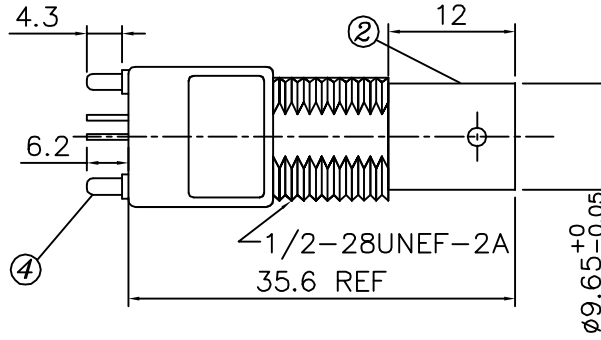

LOCK WASHER

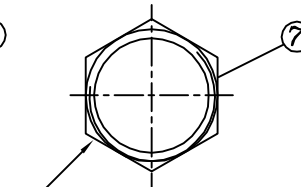

1/2-28UNEF-2B
CLAMP NUT

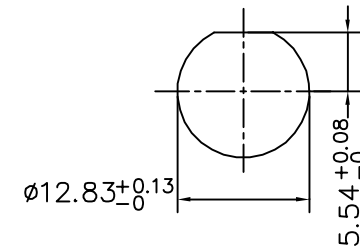
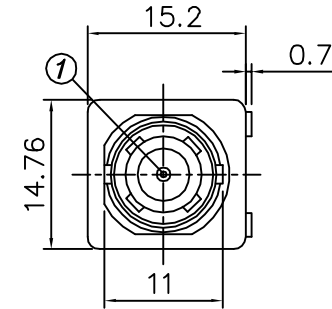

RECOMMENDED MOUNTING HOLE
MAXIMUM PANEL THICKNESS: 5.5MM

MATERIAL & FINISH

- ① CENTER CONTACT : BRONZE, GOLD PLATING
- ② BODY : ZINC ALLOY NICKEL PLATING
- ③ INSULATOR : PE-606
- ④ MOUNTING POST : BRONZE, TIN PLATING
- ⑤ SOLDER TAIL : COPPER WIRE, TIN PLATING
- ⑥ WASHER : STEEL, NICKEL PLATING
- ⑦ NUT : BRASS, NICKEL PLATING



Phone 1-800-809-2751

Fax 1-510-440-0579

www.connect-tech-products.com • info@connect-tech-products.com

4428 Technology Drive • Fremont, CA 94538, USA • 510-498-8815 • Fax: 510-440-0579